

# SWITCH CATALOG



# Series - C100, W100, WC150

# PUSHBUTTON SWITCHES Uniform Panel Appearance Switches

FEATURES	SPECIFICATIONS	CURRENT RATINGS						
		28VDC			125VAC 60/400 HZ			
		Resistive Load	Inductive Load	Lamp	Resistive Load	Inductive Load <sup>③</sup>	Lamp	
<ul style="list-style-type: none"> <li>Low level switching capability</li> <li>Moisture-proof</li> <li>Momentary action (except #7 button)</li> <li>Push-Pull action (#7 button only)</li> <li>Up to 1 million mechanical cycles</li> <li>EMI/RFI shielding available</li> <li>Tease resistant, snap action</li> <li>Six circuit arrangements available</li> <li>Various adapter, button styles and colors</li> <li>High contact pressure</li> <li>Compact size</li> <li>Corrosion resistant case and adapters</li> </ul>	<ul style="list-style-type: none"> <li>MS27903 (WC150 series only)</li> <li>Operating temperature: -40°F to +158°F (-40°C to +70°C)</li> <li>Electrical life: 25,000 cycles at rated load</li> <li>Operating force: Approx. 2.5-5 lbs (Momentary) Approx. 1.5-2.5 lbs (Push-Pull)</li> <li>Total plunger travel: 0.085 in. (2.16mm) approx.</li> <li>W100 and WC150 exceeds seal level 2 per MIL-PRF-8805</li> <li>C100 series unsealed</li> </ul>	Part Number	10 <sup>①</sup>	5	3	10 <sup>①</sup>	5	3
		C100 Series	10 <sup>②</sup>	5	3	10 <sup>②</sup>	5	3
		W100 Series	—	2	—	—	—	—
		WC1500 Series	10	5	—	—	—	—

<sup>①</sup>3 amps max. through center terminal of A800 and A11200  
<sup>②</sup>3 amps max. through center terminal of W104 and W105  
<sup>③</sup>p.f. = .75  
<sup>④</sup>EMI/RFI shielded

## SELECTION TABLE

SERIES AND TYPE	Base Switch - Catalog Number				Options - Suffix Number							
	Solder Lug Terminals				Mounting Adapters		Auxiliary Buttons					
	Non-Sealed		Sealed		Type	Color	Style	Color				
	Normal Force	Light Op. Force (2 +/- .5 lb.)	Normal Force	Light Op. Force (2 +/- 1 lb.)								
C100	SP-NO	C100	C111	-	-	Standard: N, P, PA, W, L (with #5 button only) Optional: D, E, HA, J, M, PL, U, Y	B=Black R=Red No Alpha=Clear	2, 6, or 7 on switch without adapter	No Alpha= Black R=Red W=White			
	SP-NC	C3100	C112	-	-							
	1 P.D.T.-2 Ckt.	C200	C113	-	-							
	SP-NO 3Term.	A800	C114	-	-							
	SP-NC 3Term.	A11200	C115	-	-							
1 P.D.T. Dbl Brk	C4100	C116	-	-	2, 3, 4 or 7 on switches with adapter							
W100	SP-NO	-	-	W101	W111			Standard: N, P, PA, W, L (with #5 button only) Optional: D, E, HA, J, M, PL, U, Y		B=Black R=Red No Alpha=Clear	2, 3, 4, 6 or 7	No Alpha= Black R=Red W=White
	SP-NC	-	-	W102	W112							
	1 P.D.T.-2 Ckt.	-	-	W103	W113							
	SP-NO 3Term.	-	-	W104	W114							
	SP-NC 3Term.	-	-	W105	W115							
1 P.D.T. Dbl Brk	-	-	W106	W116	2, 3, 4, 6 or 7							
WC150	2 P.D.T. 4 Ckt. May be Jumpered for 2 P.D.T.	-	-	WC150	-				2, 3, 4, 6 or 7			

## WHEN ORDERING SPECIFY...

- Catalog number of base switch - followed by suffix numbers of options (when required) as selected from Selection Table.

Order Example:

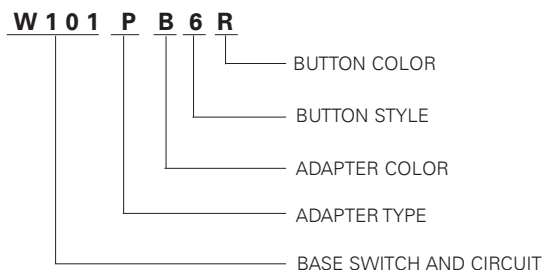
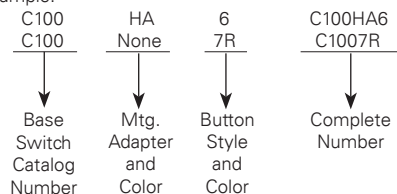

**STANDARD**  
0.00 = inches  
[0,0] = mm

Dimensions for reference only.

# PUSHBUTTON SWITCHES

## Series - C100, W100, WC150

## Uniform Panel Appearance Switches

### APPROXIMATE DIMENSIONS - PUSHBUTTON SWITCHES

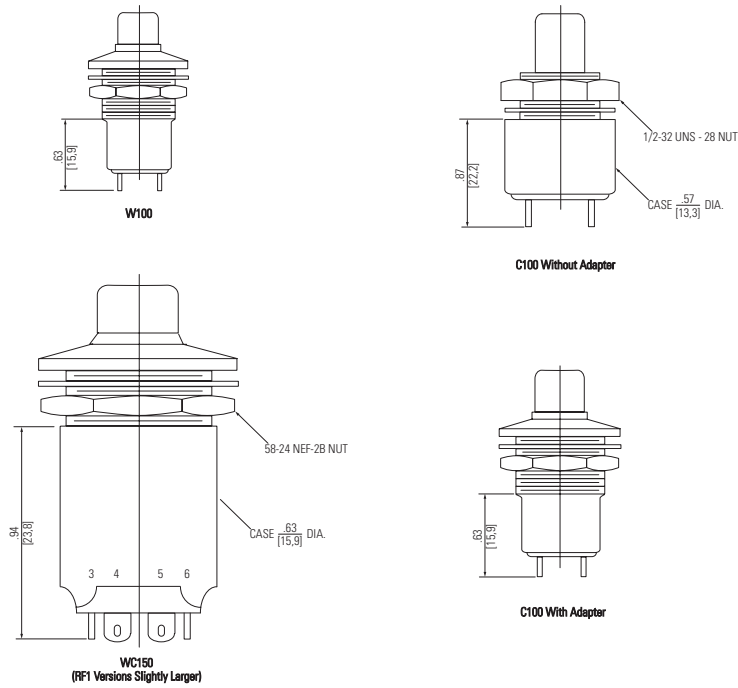

### APPROXIMATE DIMENSIONS - AUXILIARY BUTTONS

	Style Number 2		Style Number 3		Style Number 4		Style Number 6		Style Number 7	
	A	B	A	B	A	B	A	B	A	B
Series Number	mm.	in.	mm.	in.	mm.	in.	mm.	in.	mm.	in.
<b>Series C100</b>										
Without Adapter	7.9	.31	-	-	-	-	7.9	.31	4.8	.19
With Adapter	9.5	.37	9.5	.37	7.9	.31	-	-	7.9	.31
<b>Series W100 &amp; WC150</b>										
With Adapter	9.5	.37	7.9	.31	9.5	.37	7.9	.31	9.5	.37
Without Adapter		.37		.34		.37		.38		.41

### SCHEMATIC DIAGRAMS

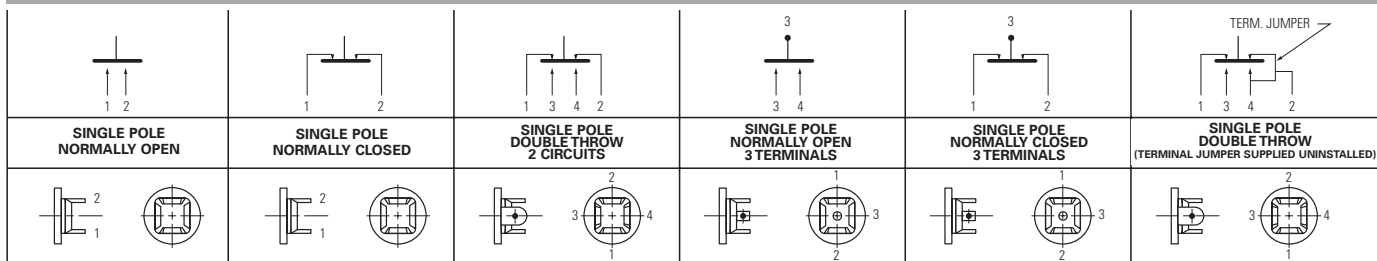

#### STANDARD

0.00 = inches

[0,0] = mm

Dimensions for reference only.

# Series - C100, W100, WC150

# PUSHBUTTON SWITCHES Uniform Panel Appearance Switches

## APPROXIMATE DIMENSIONS - MOUNTING ADAPTERS

### STANDARD:

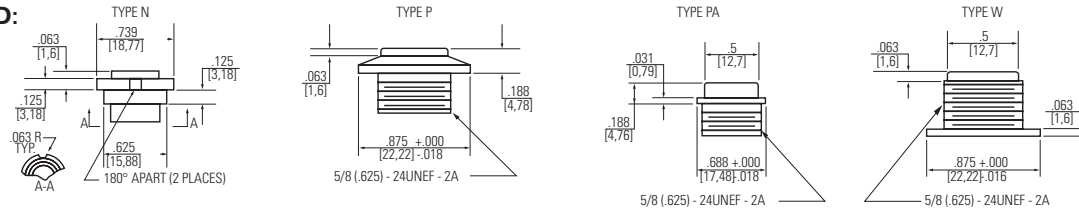

### PLUNGER CAP COLORS:

CHROME: NO LETTER  
 RED: R  
 BLACK: B  
 TOTAL PLGR TRAVEL: .438 APPROX.  
 OVERTRAVEL: .313 APPROX.

### TYPE L WITH 5 PLUNGER CAP

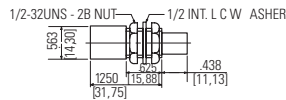

### OPTIONAL:

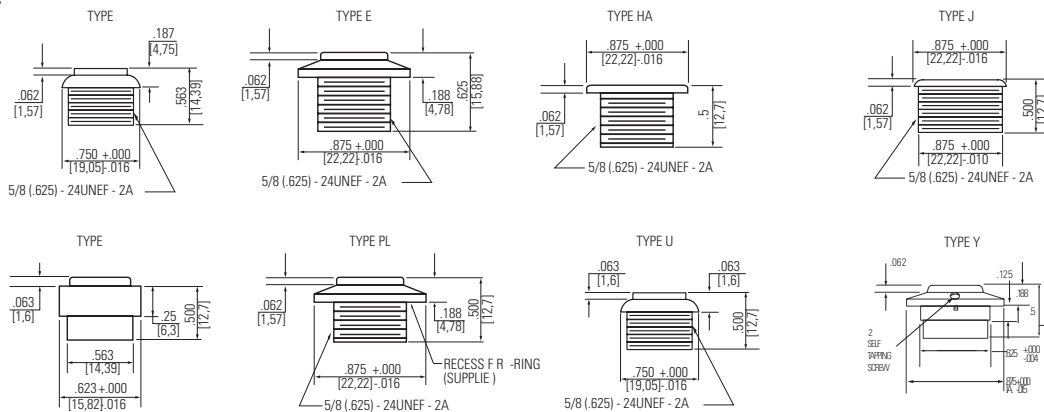

NOTE: INTERNAL THREADS 1/2 - 32 UNS-2B

## EMI/RFI SHIELDED



W1501

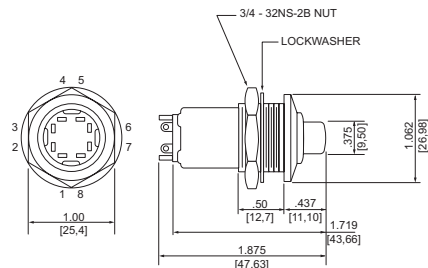

### SCHEMATIC

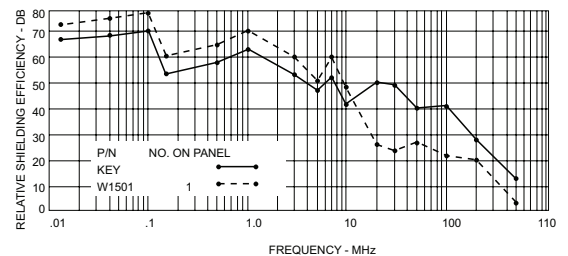
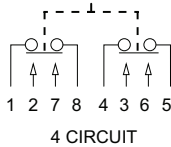

Graphic Illustration defines relative shielding efficiency of RFI shielded component/ components over unshielded device.



W403P6

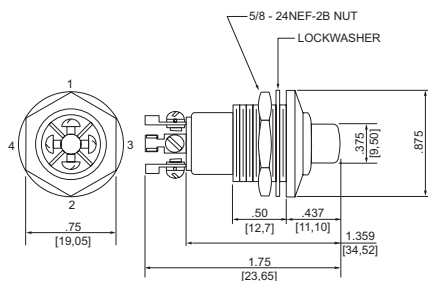

### SCHEMATIC

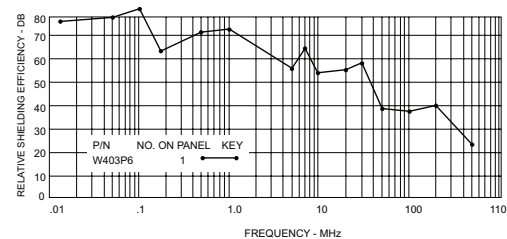
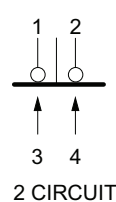

Graphic Illustration defines relative shielding efficiency of RFI shielded component/ components over unshielded device.

### STANDARD

0.00 = inches

[0,0] = mm

Dimensions for reference only.