

ENGINEERING DATA SHEET

SERIES WL

CONTACTOR, MAGNETIC LATCH
275 AMP, 3PDT

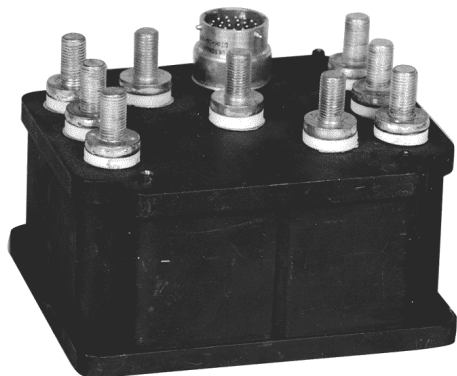

Balanced-Force Design
Hermetically sealed
Designed to the performance standards of **MIL-PRF-6106**

PRINCIPLE TECHNICAL CHARACTERISTICS

Contacts rated at **28 Vdc and 115 Vac, 400 Hz, 1 Ø and 115/200 Vac, 400Hz, 3 Ø**

Weight **4.50lbs max**

Special units available upon request, including models with auxiliary contacts.

APPLICATION NOTES:

- [101](#)
- [102](#)
- [104](#)
- [007](#)

CONTACT ELECTRICAL CHARACTERISTICS

Contact rating per pole and load type	Load current in Amps		
	28 Vdc	115 Vac 400 Hz	115/200 Vac 400 Hz, 3Ø
Resistive	125	275	275
Inductive [1]	75	275	275
Motor	75	175	175



Featuring **LEACH**® power and control solutions
www.esterline.com

AMERICAS
6900 Orangethorpe Ave.
P.O. Box 5032
Buena Park, CA 90622

Tel: (01) 714-736-7599
Fax: (01) 714-670-1145

EUROPE
2 Rue Goethe
57430 Sarralbe
France

Tel: (33) 3 87 97 31 01
Fax: (33) 3 87 97 96 86

ASIA
Units 602-603 6/F Lakeside 1
No.8 Science Park West Avenue
Phase Two, Hong Kong Science Park
Pak Shek Kok, Tai Po, N.T.
Hong Kong

Tel: (852) 2 191 3830
Fax: (852) 2 389 5803

Data sheets are for initial product selection and comparison. Contact Esterline Power Systems prior to choosing a component.

COIL CHARACTERISTICS (Vdc)**SERIES WL**

CODE	A Vdc	N [5] Vdc
Nominal operating voltage	28	28
Maximum operating voltage	29	29
Set & reset voltage, maximum		
- Nominal	18	18
- High temp test	20	20
- Continuous current test	22.5	22.5
Drop-out voltage, maximum	N/A	N/A
Coil resistance in Ohms $\pm 20\%$ at $+25^{\circ}\text{C}$ [4]	9.8	9.8

GENERAL CHARACTERISTICS

Temperature range	-55°C to +85°C
Minimum operating cycles (life) at rated resistive load	50,000
Minimum operating cycles (life) at 25% rated resistive load	100,000
Dielectric strength at sea level	
- All circuits to ground and circuit to circuit	1500 Vrms
- Coil to ground and aux. contacts	1250 Vrms
Dielectric strength at altitude:	
- Main contacts	700 Vrms
- Coil and aux. contacts	500 Vrms
Insulation resistance	
- Initial (500 Vdc)	100 M Ω min
- After environmental tests (500 Vdc)	50 M Ω min
Sinusoidal vibration	10 G / 60 to 2000 Hz
Shock (10-12 ms duration)	20 G
Maximum contact opening time under vibration and shock	10 μs
Operate time at nominal voltage (Including bounce)	20 ms max
Contact bounce at nominal voltage	4.0 ms max
Weight	4.50lbs max.
Overload	1375 Amperes
Rupture	1925 Amperes
Altitude	80,000 Feet

NUMBERING SYSTEM

SERIES WL

	WL	-	X	0	X
Relay family_____					
1-Mounting Style(A,B,Etc.)_____					
2-Terminal & Circuit _____					
3-Coil Voltage(A & N)_____					

NOTES

- [1] Inductive load life, 20,000 cycles.
2. Terminal strength per para. 3.4.8.2.1 of MIL-R-6106.
3. Alternate contact configurations and other special models available upon request. Please contact factory.
- [4] Coil is self de-energizing. Do not ramp up voltage on these coils.
- [5] "N" coil has back EMF suppression to 62 volts max.
6. This series drawing is for general use only. Please consult factory for special requirements.

MOUNTING STYLE A

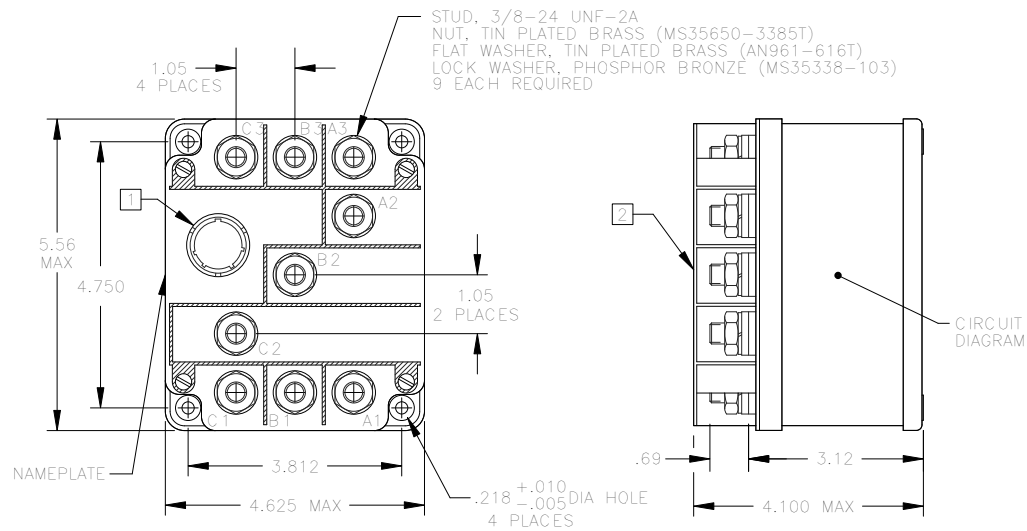

MOUNTING STYLE B

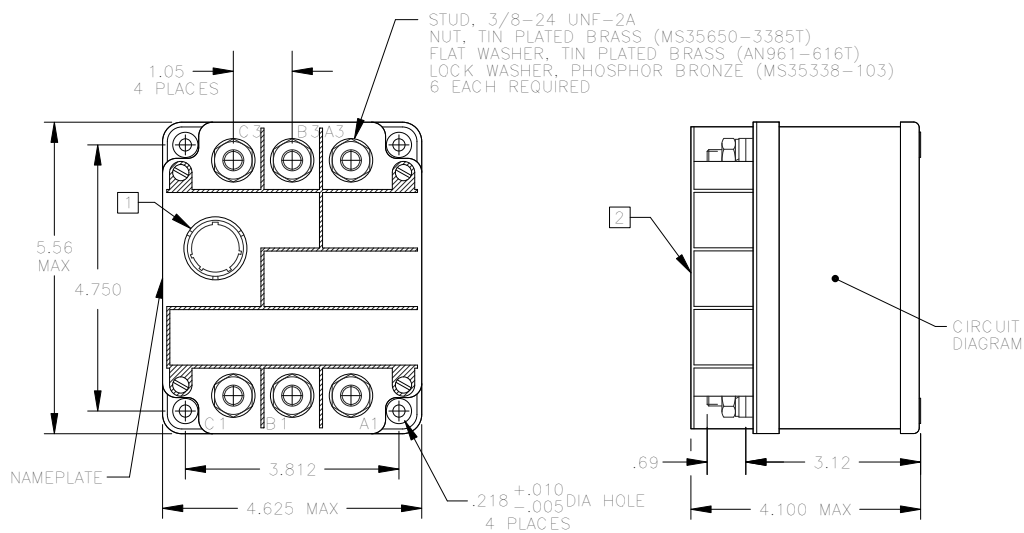

MOUNTING STYLE C

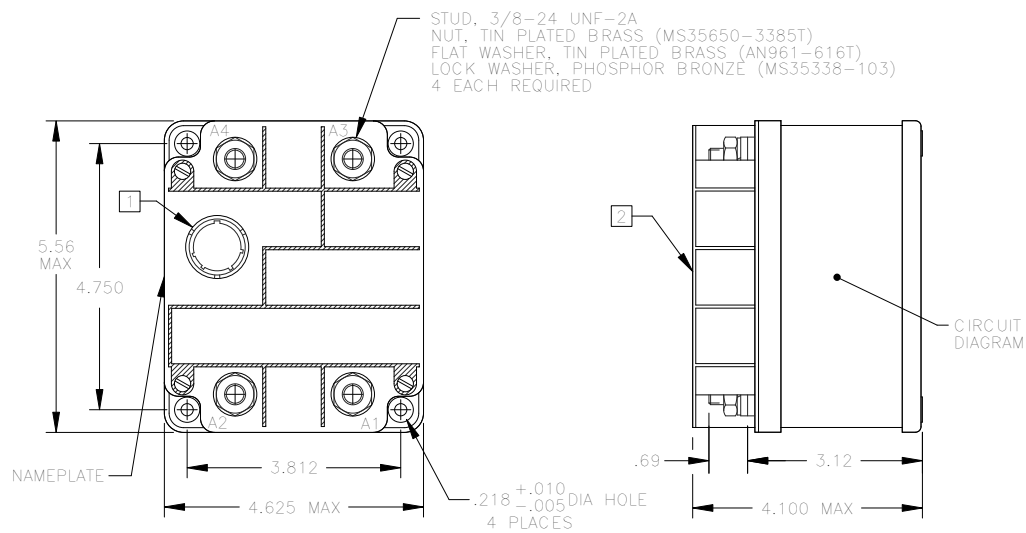

COIL CIRCUIT CONFIGURATION 3

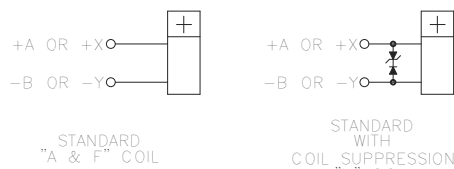

- 1 CONNECTOR - MS3113H-16-26P OR EQUIVALENT.
- 2 TERMINAL BARRIER (SHOWN WITHOUT COVER IN TOP VIEW, FOR CLARITY).
- 3 COIL TERMINALS MAY BE IDENTIFIED AS A-B OR X-Y.

STANDARD TOLERANCE: XX \pm .03, XXX \pm .010

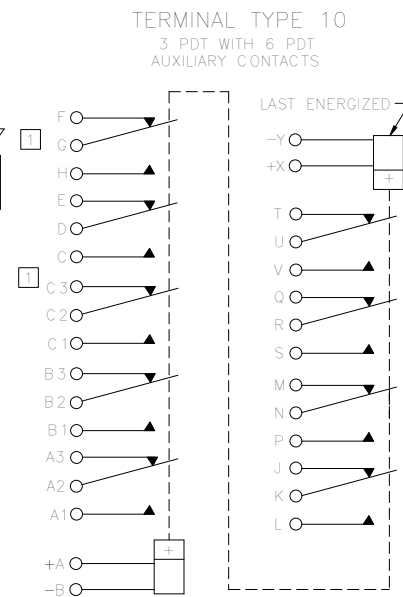
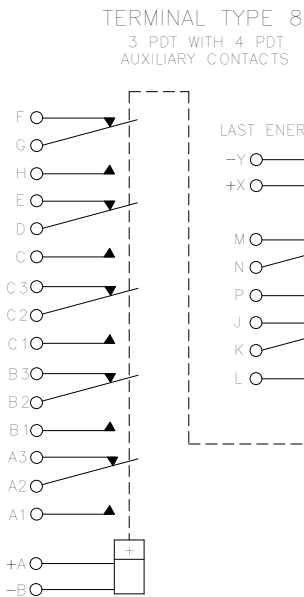
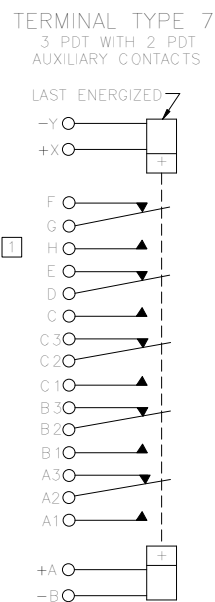
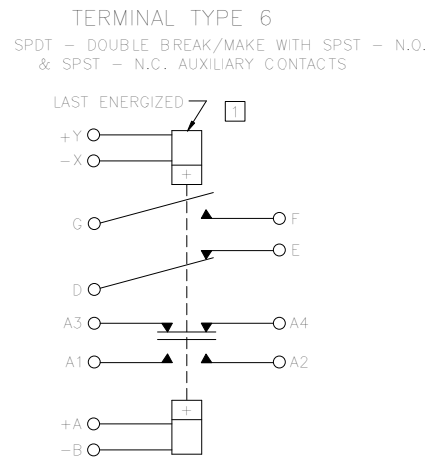
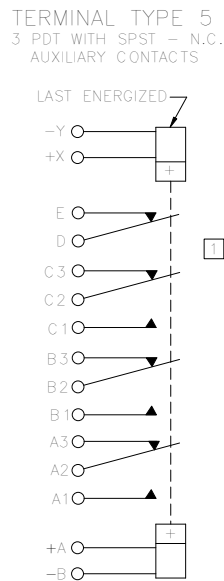
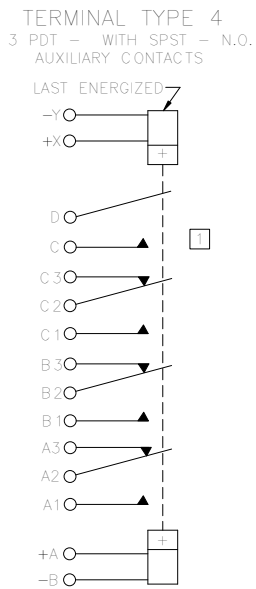
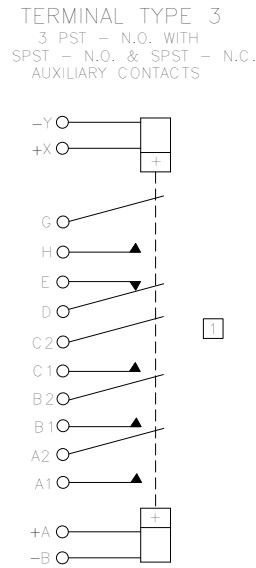
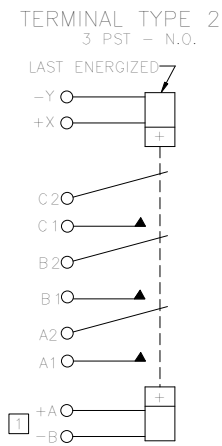
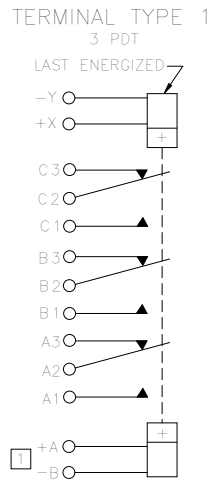

TERMINAL TYPE 9
IS A GENERAL CATEGORY USED FOR ALL
TERMINAL TYPES NOT ILLUSTRATED.
FOR OTHER VARIATIONS OF TERMINAL
CONFIGURATIONS
PLEASE CONTACT FACTORY.

1 AUXILIARY CONTACT RATING: 28 VDC OR 115 VAC

RESISTIVE	8 AMP
INDUCTIVE	5 AMP
LAMP	3 AMP
BOUNCE AT NOMINAL VOLTAGE	.004 SEC MAX

OTHER AUXILIARY CONTACT FORMS AVAILABLE,
INCLUDING LOW LEVEL CAPACITY

NOTE: Although all configuration and/or terminal type options are available, some combinations may require a setup charge and be subject to minimum order size.