

SWITCH CATALOG



PUSHBUTTON SWITCHES

Series - H2200 Double Pole

Momentary Snap Action Pushbutton Switches

FEATURES

- Double pole
- Optional mounting adapters
- Various styles and colors of pushbuttons
- Solder terminals
- Momentary snap action
- Protective shields can be ordered separately to prevent accidental actuation on "W" case model
- Black pushbutton supplied as standard
- Other colors available

SPECIFICATIONS

- Operating force: 5.5 ± 1.5 lbs (24.2N \pm 6.6N)
- Release force: 1 lb. minimum (.45g)
- Electrical life: 25,000 operations minimum at rated load
- Terminals: Solder
- Weight approx.: .05 lb. (.023g)







CURRENT RATINGS

Catalog Number	Number of Poles	Type of Operation	28VDC Inductive	120VAC Inductive ^①
H2211	2	Momentary	10	10
H2222	2	Momentary	10	10
H2266	2	Momentary	10	10

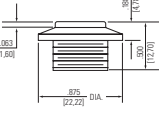
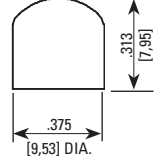
^① p.f.=.75

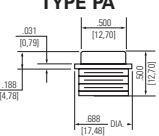
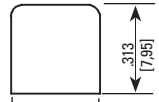
SELECTION TABLE

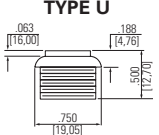
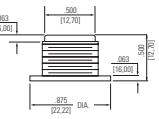
SERIES AND TYPE

Part Number	Circuit	Adapter Type ^① and Color ^③			Pushbutton Type and Color			
		Type	Color	Code Suffix	Type ^②	Color	Code Suffix	
 H2211PB3 With "P" Adapter	2 P.S.T.-NO Double Break	 TYPE P	Black	PB	 NO. 2	Red	2R	
	2 P.S.T.-NC Double Break		Clear	P		Black	2	
 H2266 Without Mounting Adapter	2 P.D.T. Double Break	 TYPE PA	Black	PAB	 NO. 3	Red	3R	
			Clear	PA		Black	3	
			Black	UB		 NO. 4	Red	4R
			Clear	U			Black	4
 TYPE U	 TYPE W	Black	WB	 NO. 4	Red	4R		
		Clear	W		Black	4		

^① Clear anodized aluminum is standard. All threads are 1/2"-32 NS-2B internal; 5/8"-24 NEF-2A external except as noted.

^② The different pushbutton types are only available when using with one of the 4 different adapters.

^③ When used with any of these adapters the switch can be used as part of the UPA group of switches on pages B16 and B17.

WHEN ORDERING SPECIFY...

- For switch with pushbutton only - specify catalog number of base switch followed by code for pushbutton color. Use code R for red and leave blank if black button is desired. Examples:

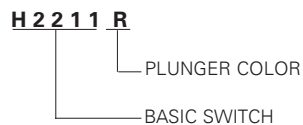

- For switch with mounting adapter - specify catalog number of base switch followed by suffix letters and numbers for type and color of adapter and pushbutton. Example:

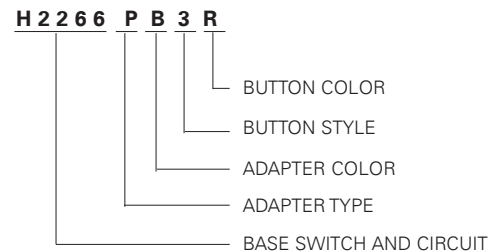

Series - H2200 Double Pole

PUSHBUTTON SWITCHES Momentary Snap Action Pushbutton Switches

APPROXIMATE DIMENSIONS - H2200

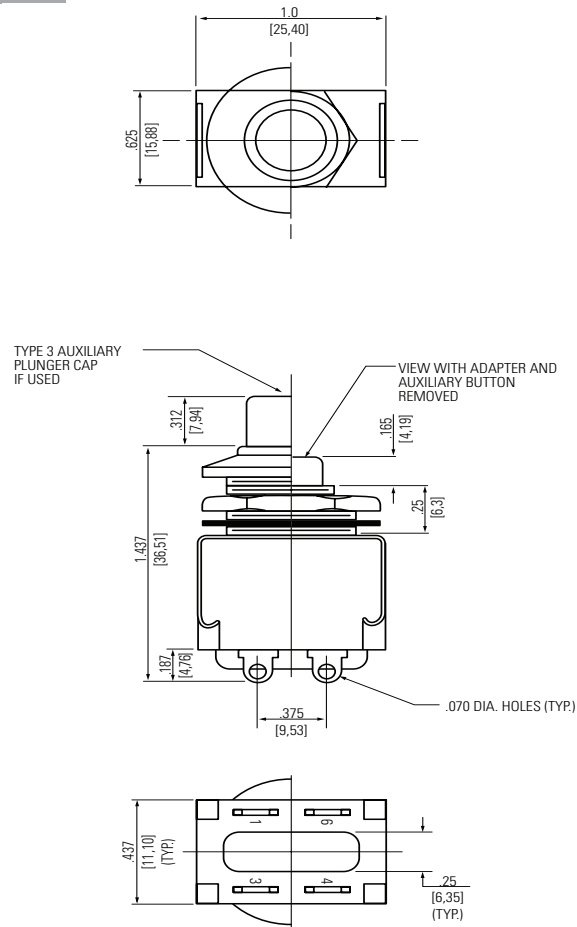

BASIC SWITCH AND SCHEMATIC DIAGRAM

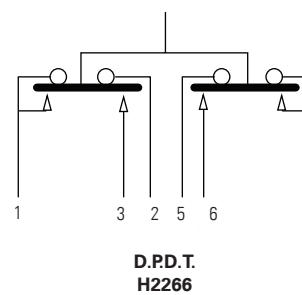
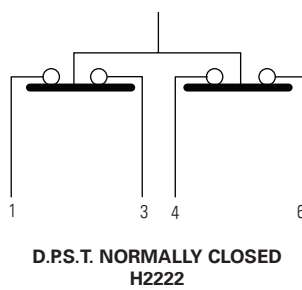
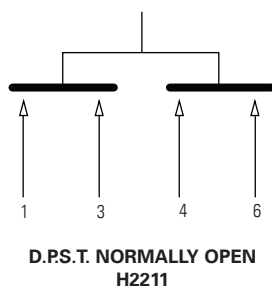

STANDARD
0.00 = inches
[0,0] = mm

Dimensions for reference only.