

MINIATURE MICROSWITCHES - SEALED, DOUBLE BREAK

83139

- › Double-break flexible leaf snap-action mechanism
- › IP66/IP67 protection
- › Wire lead or cable output
- › ATEX/IECEx certified flameproof version for use in explosive gas atmospheres
- › Oil and hydrocarbon-resistant version
- › Two-pole/DPDT version with synchronized switchings
- › Class II version with double insulation
- › Ratings from 1 mA 4 V_{DC} to 6 A 250 V_{AC}~
- › Operating temperature from -40 °C up to 105 °C
- › Wide choice of actuators (pre-assembled or retrofittable)

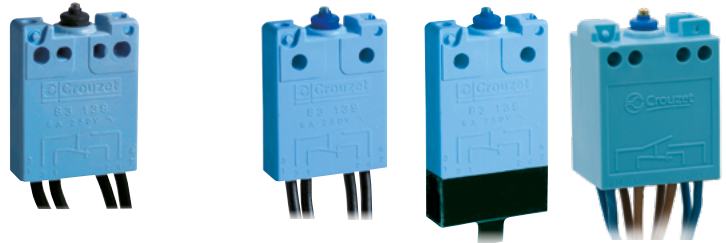

Main specifications

			Standard 831395	Oil-resistant 831390	Flameproof 831391	Double insulation 831392	Two-pole 831398
Function / Fixing	Connections	Actuators					
I (changeover) / A (4 holes)	S0.5 (wires, standard)	No	83139503	83139003	-	-	83139801
I (changeover) / A (4 holes)	G0.5 (wires, left)	No	●	●	-	-	-
I (changeover) / A (4 holes)	D0.5 (wires, right)	No	●	●	-	-	-
I (changeover) / A (4 holes)	C0.5 (cable)	No	●	●	-	-	-
I (changeover) / B (2 holes)	S0.5 (wires, standard)	No	83139518	●	83139103	-	-
I (changeover) / B (2 holes)	G0.5 (wires, left)	No	●	●	●	-	-
I (changeover) / B (2 holes)	D0.5 (wires, right)	No	●	●	83139104	-	-
I (changeover) / B (2 holes)	C0.5 (cable)	No	●	●	83139130	83139201	-
Configurations with actuators		Yes	See page 5	See page 5	See page 5	See page 5	
Electrical characteristics							
Rating nominal / 250 V AC (A)			6	6	6	6	6
Rating thermal / 250 V AC (A)			11	11	11	11	11
Mechanical characteristics							
Maximum operating force (N)			3	3	3	3	4.5
Min. Release force (N)			0.6	0.6	0.6	0.6	0.8
Maximum total travel force (N)			4	4	4	4	6
Max. Allowable overtravel force (N)			10	10	10	10	20
Rest position max, fixing A (mm)			8.8	8.8	-	-	8.8
Rest position max, fixing B (mm)			9.8	9.8	9.8	9.8	-
Operating position, fixing A (mm)			7.7 ±0.4	7.7 ±0.4	-	-	7.7 ±0.4 *
Operating position, fixing B (mm)			8.7 ±0.4	8.7 ±0.4	8.7 ±0.4	8.7 ±0.4	-
Differential travel (mm)			0.35 ±0.1	0.35 ±0.1	0.35 ±0.1	0.35 ±0.1	0.35 ±0.1
Min. Overtravel (mm)			0.25	0.25	0.25	0.25	0.25
Ambient operating temperature (° C)			-40 → +85	0 → +85	-40 → +70	-40 → +85	-40 → +85
Mechanical life (operations)			5 x 10 ⁶	10 ⁷	5 x 10 ⁶	5 x 10 ⁶	5 x 10 ⁶
Contact gap, wire versions (mm)			0.3 x 2	0.3 x 2	0.3 x 2	-	0.3 x 2
Contact gap, cable versions (mm)			0.3	0.3	0.3	0.3	-
Weight, wire versions (g)			33	33	33	-	62
Weight, cable versions (g)			31	31	31	31	-

* Max. deviation between the operating positions of both poles of a single switch: 0.1 mm
(For reduced max. deviation, down to 0.06 mm : please consult us)

Additional specifications

- Case: PBT GF (UL 94-V0 / GWFI 960 °C)
- Button: stainless steel, POM (831392), brass (831398)
- Membrane: blue fluorosilicone rubber, black nitrile rubber (831390)
- Moving blade: beryllium copper
- Contacts: silver (gold-plated silver : on request)
- Wire leads, Cable: copper, PVC insulated
- Levers: stainless steel, polyamide roller

- Degree of protection: IP66/IP67
- Protection against electric shock: 831392 is suitable for Class II equipment up to 250 V without additional protection
- Recommended min actuating speed: 0.01 mm/s
- 831391 Ex features:
conform to IEC/EN 60079-0 and IEC/EN 60079-1
conform to 2014/34/EU directive
marking: 0081 Ex II 2 G - Ex d IIC Gb
suitable for Zone 1
EC type examination certificate: LCIE 02 ATEX 0034 U
IECEx certificate of conformity: IECEx LCIE 13.0035U
see also "installation recommendations"

- Conformity / Certifications: on request (except 831398) / (831391) /

Standard product

Product made to order

● Contact us

Product adaptations



- › Special levers : special shapes and lengths
- › Special leads and cables (EN 50306 halogen-free, oil-resistant, ...), full wiring with custom connector
- › Functions on request : normally closed (R) or normally open (C) SPST or DPST microswitches
- › 3-wire single break changeover SPDT (form C): "Common point" option
- › High operating temperature : +105 °C
- › Dual-current version with gold plated contacts for use from 1 mA to 5 A
- › Telescopic plunger with up to 4 mm overtravel and adjustable fixing by threaded barrel (SP4257)
- › cURus approved versions (except 831398)

Principles

Double break snap-action switch

Changeover - SPDT (form Za)

Types 831390/831391/831395 with wire output

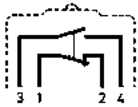

Single break snap-action switch

Changeover - SPDT (form C)

Types 831390/831391/831392/831395 with cable output



Double break snap-action switch

Changeover - DPDT (2 x form Za)

Type 831398

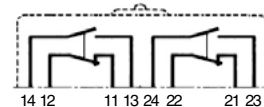

Curves

Operating curve for types

831390 / 831391 / 831392 / 831395 / 831398

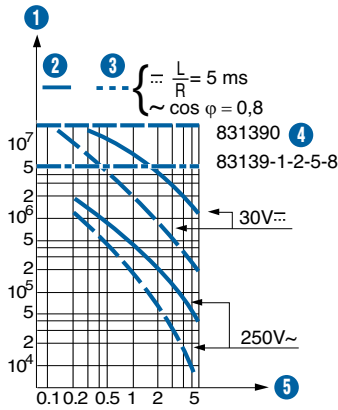

- ① Number of cycles
- ② Resistive circuit
- ③ Inductive circuit
- ④ Mechanical life limit
- ⑤ Current in Amps

Dimensions

Products and Connections

83139 - wire output

831390 - 831395
Fixing A (4 holes)

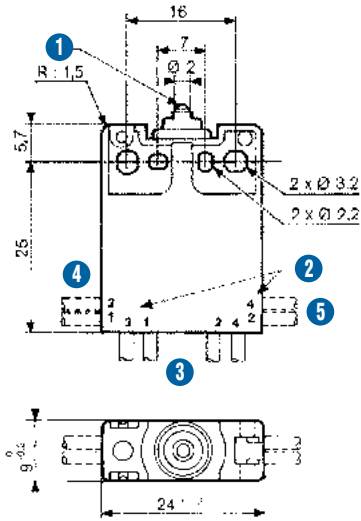

- ① R: 1.5 spherical
- ② Wire identification
- ③ S wire output on bottom, standard: 1-2-3-4=black
- ④ G wire output on left: 1 = black, 2 = brown, 3 = grey, 4 = blue
- ⑤ D wire output on right: 1 = black, 2 = brown, 3 = grey, 4 = blue

Wire characteristics: Cross section: 0.75 mm²
Standard length: 0.5 m
Other lengths on request (length in meters: e.g. 1.5)

831390 - 831391 - 831395
Fixing B (2 holes)

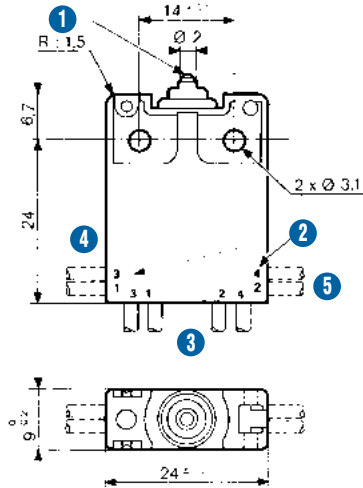

831398

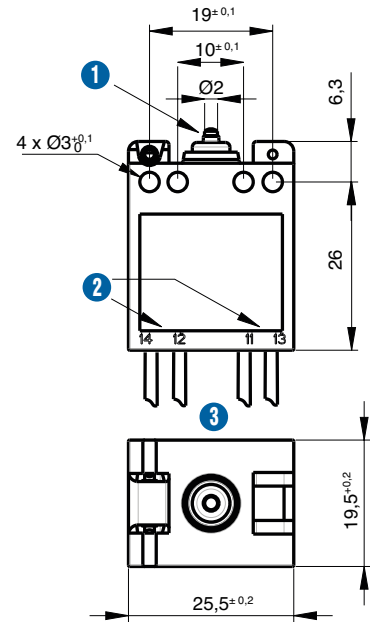

- ① R: 1.5 spherical
- ② Wire identification
- ③ S wire output: 11-12-21-22 = brown
13-14-23-24 = blue

83139 - cable output

831390 - 831395
Fixing A (4 holes)

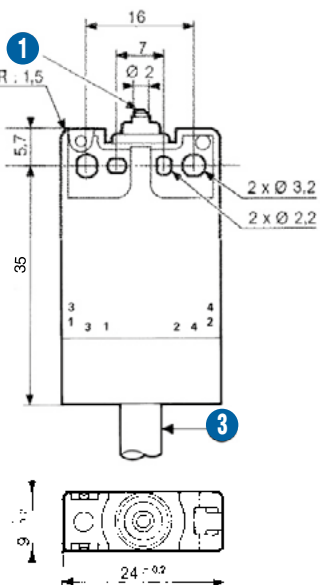

831390 - 831391 - 831392 - 831395
Fixing B (2 holes)

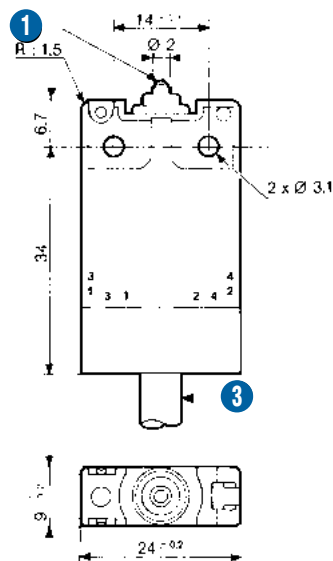

1 R: 1.5 spherical

3 C cable output: 1 = black, 2 = brown, 4 = blue

Cable characteristics: Cross section: 3 x 0.75 mm²
 Standard length: 0.5 m
 Other lengths on request (length in meters: e.g. 1.5)

Actuator mounting positions

139-type levers (pinned)

831390 - 831395
 Fixing A (4 holes)

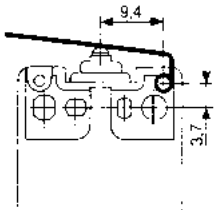

831390 - 831391 - 831392 - 831395
 Fixing B (2 holes)

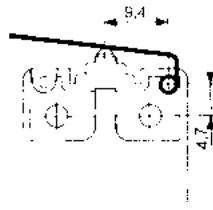

831398 (consult us)

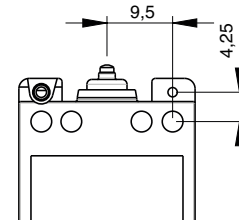

161-type levers (clipped-on)

831390 - 831395
 Fixing A (4 holes)

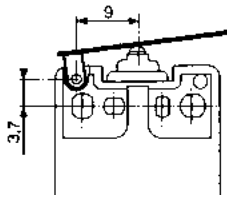

831390 - 831391 - 831392 - 831395
 Fixing B (2 holes)

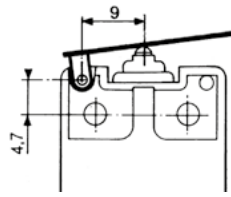

831398

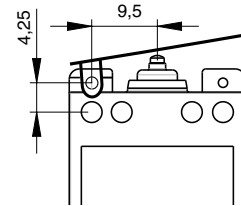

Actuators

139AX flat

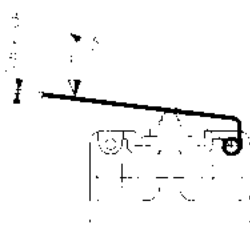

139EX roller

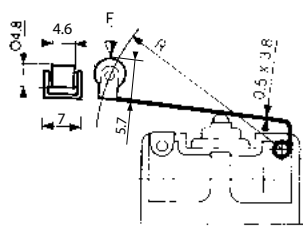

161A flat



161E roller

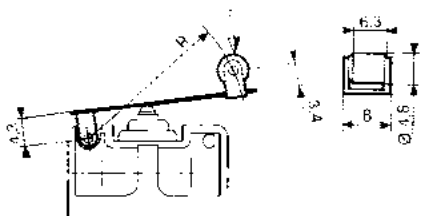

161F dummy roller

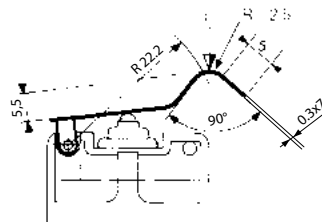

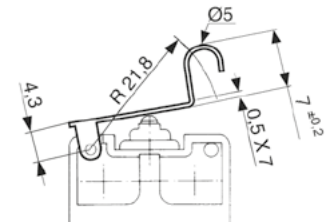

161G dummy roller





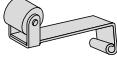

Other shapes and dimensions: consult us

Actuators and mounting accessories

Part numbers for standard actuators

		79211671*		79211674*		79215740		70507524	
Actuators		Flat 139AX R29.7		Roller 139EX R28.7		Flat 161A R14.2		Flat 161A R25.4	
									
		831390/1/2/5	831398	831390/1/2/5	831398	831390/1/2/5	831398	831390/1/2/5	831398
Operating force max.	N	1.5	-	1.5	-	2.6	3.9	1.7	2.6
Release force min.	N	0.2	-	0.2	-	0.35	0.5	0.2	0.3
Operating position, fixing A mm		8.2±1.2	-	13.4±1.2	-	8.2±0.6	8.1±0.6	8.2±1	7.3±1
Operating position, fixing B mm		9.2±1.2	-	14.4±1.2	-	9.2±0.6	-	9.2±1	-
Differential travel max.	mm	1.5	-	1.5	-	0.7	0.7	1.25	1.35

Part numbers for standard actuators

		79215742		70507529		70507528		79218651	
Actuators		Roller 161E R13.6		Roller 161E R24.1		Dummy roller 161F R22.2		Dummy roller 161G R21.8	
									
		831390/1/2/5	831398	831390/1/2/5	831398	831390/1/2/5	831398	831390/1/2/5	831398
Operating force max.	N	2.6	3.9	1.7	2.6	2	3	2	3
Release force min.	N	0.35	0.5	0.2	0.3	0.2	0.3	0.2	0.3
Operating position, fixing A mm		13.9±0.7	13.6±0.7	13.9±1	12.9±1	13.3±1	12.4±1	14.7±1	13.8±1
Operating position, fixing B mm		14.9±0.7	-	14.9±1	-	14.3±1	-	15.7±1	-
Differential travel max.	mm	0.7	0.7	1.2	1.3	1.1	1.2	1.1	1.2

Unless mentioned specifically, 161-type levers are supplied unmounted . For factory mounting, see preferred part numbers in table below.

* 139-type levers are preferably factory mounted : see preferred part numbers in table below .

For unmounted supply, please also order associated pin [79210424](#)

Note: we recommend greasing the switch button lightly when fitting actuators, excluding greases containing silicone.

83139 microswitches with referenced actuators

Actuators	139AX R29.7	139EX R28.7	161A R14.2	161A R25.4	161E R13.6	161E R24.1	161G R21.8
	79211671	79211674	79215740	70507524	79215742	70507529	79218651
831390 I A S0.5	83139006	83139008	83139023	83139024	83139025	83139026	83139027
831391 I B S0.5	83139118	83139117	●	●	83139129	83139121	●
I B G0.5	●	83139120	●	●	●	●	●
I B C0.5	●	●	83139124**	●	●	●	●
831395 I A S0.5	83139505	83139507	●	●	●	●	●

** Actuator width is 4 mm

Installation recommendations

See "Basic technical concepts"

Special condition for safe use of 831391 in explosive atmospheres: the component must be installed in an enclosure which meets the mechanical strength requirements of IEC/EN 60079-0.

How to order

Use the 8 digit part numbers when they are defined

Other cases, precise:

Type of microswitch - Function - Fixing - Connection - UL approval* - Actuator* - Adaptation*

* if needed

Example: 831395 I B D0.5 UL 139EX R28.7

Standard product

Product made to order

● Contact us

Examples of special adaptations



Telescopic roller plunger with 2.5 mm overtravel and adjustable fixing by threaded barrel (SP4257)



2-pole DPST-NO flameproof special microswitch, for explosive atmospheres



Halogen-free wire version with flat pinned lever, for railway applications



3-wire SPDT (Form C) variant with lateral output



2-pole model with extra-short lever, stainless steel roller and extended overtravel



SPST-NO version with insulated connexions and dummy roller lever

Warning:

The product information contained in this catalogue is given purely as information and does not constitute a representation, warranty or any form of contractual commitment. Crouzet and its subsidiaries reserve the right to modify their products without notice. It is imperative that we should be consulted over any particular use or application of our products and it is the responsibility of the buyer to establish, particularly through all the appropriate tests, that the product is suitable for the use or application. Under no circumstances will our warranty apply, nor shall we be held responsible for any application (such as any modification, addition, deletion, use in conjunction with other electrical or electronic components, circuits or assemblies, or any other unsuitable material or substance) which has not been expressly agreed by us prior to the sale of our products.