

Commercial Miniature Toggle Switches

SPECIFICATIONS

- Originally designed to meet the requirements of MIL-S-83731 (see page 54 for Test Specifications).
- Sealed lever type with panel seal and terminal seal.
- Flatted bushing on sealed lever type.
- Solder lug or printed circuit terminals.
- Epoxy sealed terminals.
- One and two pole circuits.
- High electrical/mechanical reliability.
- Dry circuit current carrying ability.
- Toggle lever throw $25^\circ \pm 5^\circ$.

MATERIAL

- Base (body)** — Diallyl Phthalate.
- Lever** — Brass, bright chrome plated.
- Bushing** — Brass, nickel plated.
Frame — Stainless steel.
- Switching Contacts and Rockers** — 50 millionths gold over silver.
- Center Terminal** — 50 millionths gold over silver.
- Hardware** — Refer to hardware listing on page 57.



CURRENT RATINGS

Current Capacity in Amperes — Per Pole		
28 V DC	115 V AC 400 Hz	125 V AC 60 Hz
LAMP LOAD		
1	1	1
RESISTIVE LOAD		
5	5	5
INDUCTIVE LOAD		
2	2	2

LOGIC LEVEL

10 mA @ 5 V Max. (AC or DC)

SWITCH SELECTION TABLE — SEALED

	Circuit With Lever			Catalog Number	
	UP Position	CENTER Position	DOWN Position (Flat)	Solder Lug Terminals	Printed Circuit Terminals
	ONE POLE				
	ON	OFF	ON	A121S1CWZG-M8	A121S1CWCG-M8
	ON	NONE	ON	A123S1CWZG-M8	A123S1CWCG-M8
	ON	NONE	ON*	A126S1CWZG-M8	A126S1CWCG-M8
	ON*	OFF	ON*	A127S1CWZG-M8	A127S1CWCG-M8
	ON	OFF	ON*	A131S1CWZG-M8	A131S1CWCG-M8
ON	ON	ON*	A137S1CWZG-M8	A137S1CWCG-M8	
	TWO POLE				
	ON	OFF	ON	A221S1CWZG-M8	A221S1CWCG-M8
	ON	NONE	ON	A223S1CWZG-M8	A223S1CWCG-M8
	ON	NONE	ON*	A226S1CWZG-M8	A226S1CWCG-M8
	ON*	OFF	ON*	A227S1CWZG-M8	A227S1CWCG-M8
	ON*	OFF	ON*	A231S1CWZG-M8	A231S1CWCG-M8
	ON	ON	ON	A232S1CWZG-M8	A232S1CWCG-M8
	ON	ON	ON*	A233S1CWZG-M8	A233S1CWCG-M8
	NONE	ON	ON*	A234S1CWZG-M8	A234S1CWCG-M8
	ON*	ON	ON*	A235S1CWZG-M8	A235S1CWCG-M8

* Momentary Contact

"ON-ON-ON" CIRCUIT DIAGRAM

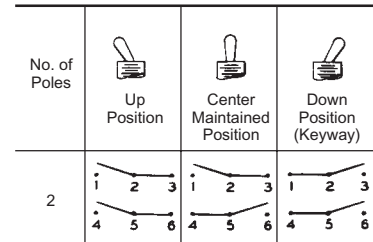

APPROXIMATE DIMENSIONS

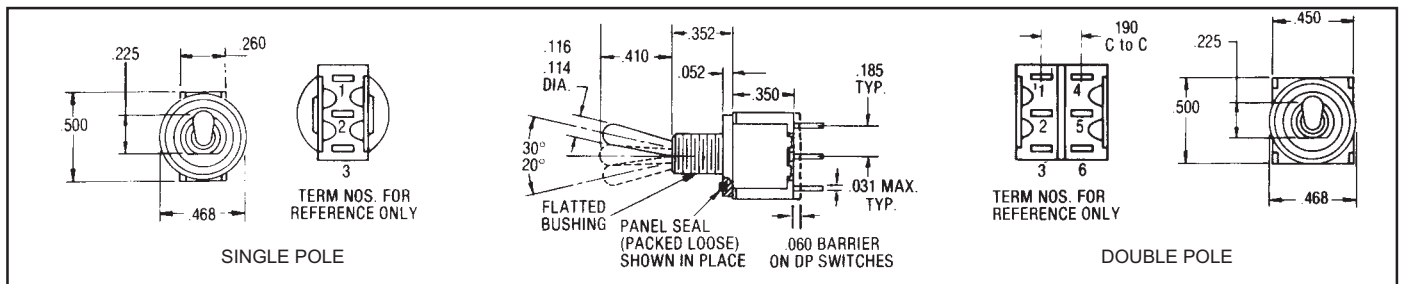

TERMINAL DIMENSIONS

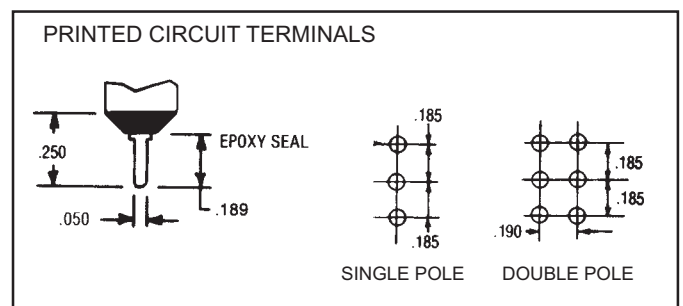
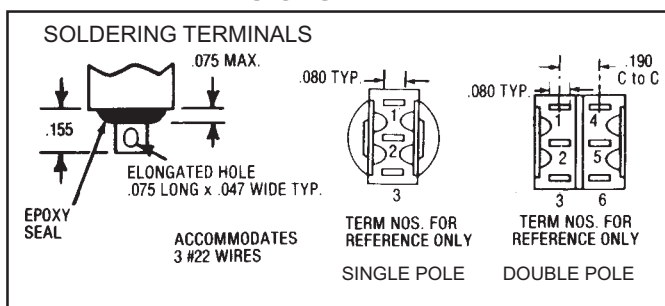

Commercial Miniature Leverlock Toggle Switches — Unsealed

SPECIFICATIONS

- One hole mounting.
- Originally designed to meet the requirements of MIL-S-83731 (see page 54 for Test Specifications).
- Slow make, slow break contact action.
- High electrical/mechanical reliability.
- Toggle lever throw $25^\circ \pm 5^\circ$.
- Solder lug or printed circuit terminals.
- One and two pole circuits.
- Dry circuit current carrying ability.
- Mounting hardware furnished unassembled

MATERIAL

- **Base (body)** — Diallyl Phthalate.
- **Locking lever** — Brass, nickel plated.
Cap — natural anodized aluminum supplied as standard; other colors such as red, blue, gold, black and green are also available.
- **Bushing** — Brass, nickel plated.
Frame — Stainless steel.
- **Switching Contacts and Rockers** — 50 millionths gold over silver.
- **Center Terminal** — 50 millionths gold over silver.
- **Hardware** — Refer to hardware listing on page 57.

CURRENT RATINGS

Current Capacity in Amperes — Per Pole		
28 V DC	115 V AC 400 Hz	125 V AC 60 Hz
LAMP LOAD		
1	1	1
RESISTIVE LOAD		
5	5	5
INDUCTIVE LOAD		
2	2	2

LOGIC LEVEL

10 mA @ 5 V Max. (AC or DC)

LEVER LOCK SELECTION TABLE

Standard Cap Style	Circuit With Lever				Catalog Number	
	UP Position	CENTER Position	DOWN Position (Keyway)	Lever Lock Bushing Style	Solder Lug Terminals	Printed Circuit Terminals
 SPDT DPDT	ONE POLE					
	ON ▶	◀ OFF ▶	◀ ON	1	A121K12KZG-M8	A121K12KCG-M8
	ON ▶	NONE	◀ ON	2	A123K12KZG-M8	A123K12KCG-M8
	ON ▶	NONE	ON*	3	A126K12KZG-M8	A126K12KCG-M8
	ON*	◀ OFF ▶	ON*	4	A127K12KZG-M8	A127K12KCG-M8
	ON ▶	◀ OFF ▶	ON*	5	A131K12KZG-M8	A131K12KCG-M8
	TWO POLE					
	ON ▶	◀ OFF ▶	◀ ON	1	A221K12KZG-M8	A221K12KCG-M8
	ON ▶	NONE	◀ ON	2	A223K12KZG-M8	A223K12KCG-M8
	ON ▶	NONE	ON*	3	A226K12KZG-M8	A226K12KCG-M8
ON*	◀ OFF ▶	ON*	4	A227K12KZG-M8	A227K12KCG-M8	
ON*	◀ OFF ▶	ON*	5	A231K12KZG-M8	A231K12KCG-M8	
ON ▶	◀ ON ▶	◀ ON	1	A232K12KZG-M8	A232K12KCG-M8	

* Momentary Contact
▶ Indicates direction against which lever is locked.

APPROXIMATE DIMENSIONS (For terminal dimensions see page 49)

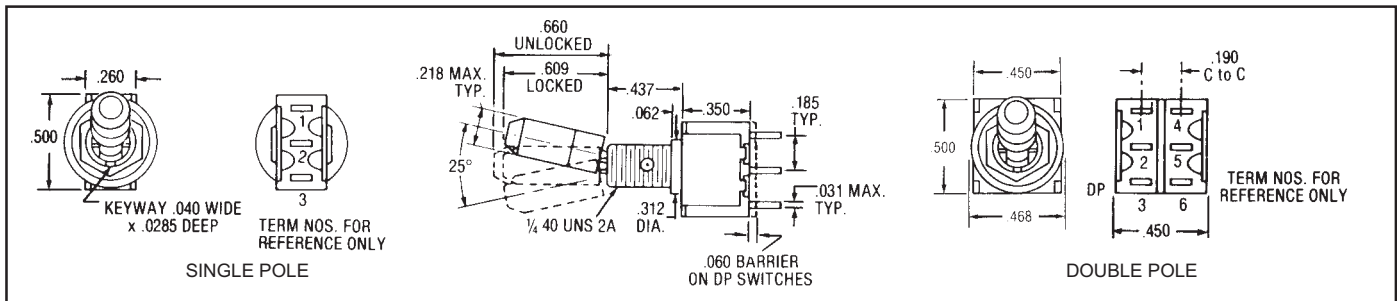

LEVER LOCK BUSHING STYLES

(The descriptive illustrations below are for pictorial representation only — keyway on right hand side)

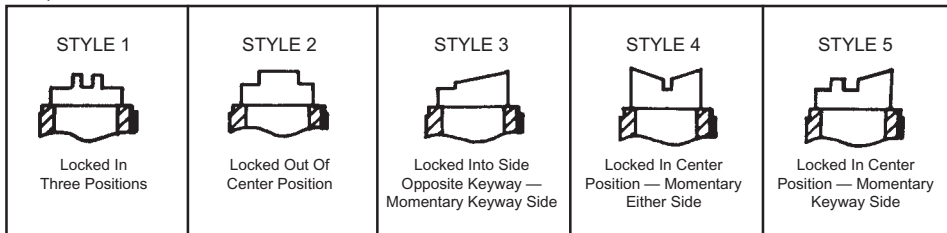

"ON-ON-ON" CIRCUIT DIAGRAM

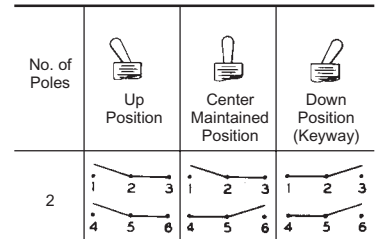

**Commercial Miniature Toggle Switches
Right Angle Mount (Vertical) P.C. Terminals**

SPECIFICATIONS

- Originally designed to meet the requirements of MIL-S-83731 (see page 54 for Test Specifications).
- Sealed lever type with panel seal and terminal seal.
- Right angle mount (vertical) printed circuit terminals.
- Epoxy sealed printed circuit terminals.
- One and two pole circuits.
- High electrical/mechanical reliability.
- Dry circuit current carrying ability.
- Toggle lever throw $25^\circ \pm 5^\circ$.

MATERIAL

- **Base (body)** — Diallyl Phthalate.
- **Lever** — Brass, bright chrome plated.
- **Bushing** — Brass, nickel plated.
Frame — Stainless steel.
- **Switching Contacts and Rockers** — 50 millionths gold over silver.
- **Center Terminal** — 50 millionths gold over silver.
- **Hardware** — None required.



CURRENT RATINGS

Current Capacity in Amperes — Per Pole		
28 V DC	115 V AC 400 Hz	125 V AC 60 Hz
LAMP LOAD		
1	1	1
RESISTIVE LOAD		
5	5	5
INDUCTIVE LOAD		
2	2	2

LOGIC LEVEL

10 mA @ 5 V Max. (AC or DC)

SWITCH SELECTION TABLE — SEALED

	Circuit With Lever In...			Catalog Number
	UP Position	CENTER Position	DOWN Position (Position C)	
 SPDT	ONE POLE			
	ON	OFF	ON	A121M1D9AVG-M8
	ON	NONE	ON	A123M1D9AVG-M8
	ON	NONE	ON*	A126M1D9AVG-M8
	ON*	OFF	ON*	A127M1D9AVG-M8
	ON	OFF	ON*	A131M1D9AVG-M8
	NONE	ON	ON*	A134M1D9AVG-M8
 DPDT	TWO POLE			
	ON	OFF	ON	A221M1D9AVG-M8
	ON	NONE	ON	A223M1D9AVG-M8
	ON	NONE	ON*	A226M1D9AVG-M8
	ON*	OFF	ON*	A227M1D9AVG-M8
	ON	OFF	ON*	A231M1D9AVG-M8
	ON	ON	ON	A232M1D9AVG-M8
	ON	ON	ON*	A233M1D9AVG-M8
	NONE	ON	ON*	A234M1D9AVG-M8
	ON*	ON	ON*	A235M1D9AVG-M8

* Momentary Contact

APPROXIMATE DIMENSIONS

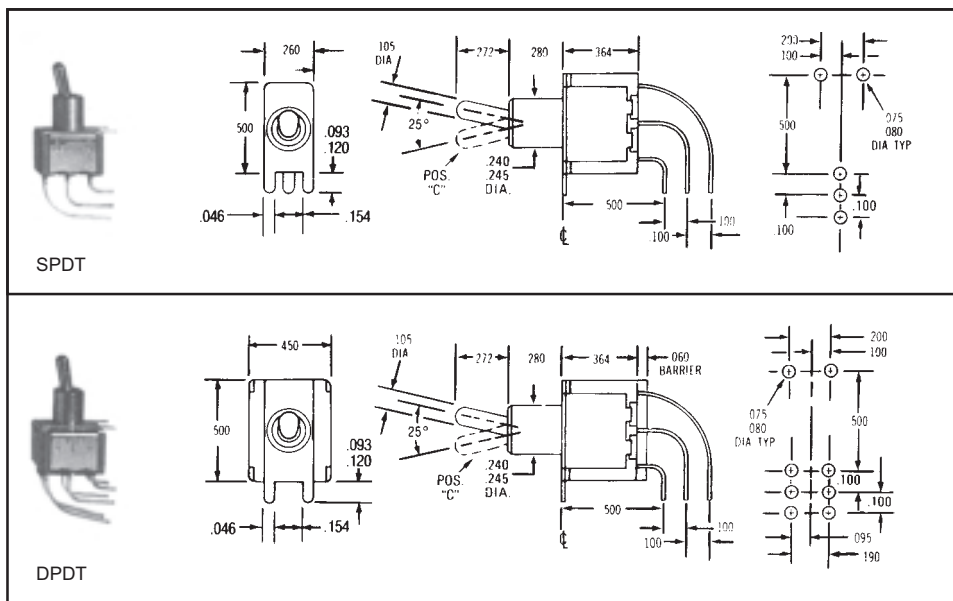

TERMINAL DIMENSIONS

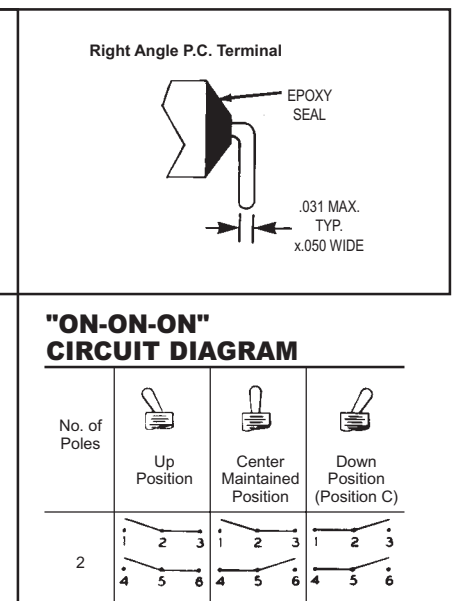

**Commercial Miniature Toggle Switches
Right Angle Mount (Horizontal) P.C. Terminals**

SPECIFICATIONS

- Originally designed to meet the requirements of MIL-S-83731 (see page 54 for Test Specifications).
- Sealed lever type with terminal seal.
- Right angle mount (horizontal) printed circuit terminals.
- Epoxy sealed printed circuit terminals.
- One and two pole circuits.
- High electrical/mechanical reliability.
- Dry circuit current carrying ability.
- Toggle lever throw $25^\circ \pm 5^\circ$.

MATERIAL

- **Base (body)** — Diallyl Phthalate.
- **Lever** — Brass, bright chrome plated.
- **Bushing** — Brass, nickel plated.
Frame — Stainless steel.
- **Switching Contacts and Rockers** — 50 millionths gold over silver.
- **Center Terminal** — 50 millionths gold over silver.
- **Hardware** — None required.



CURRENT RATINGS

Current Capacity in Amperes — Per Pole		
28 V DC	115 V AC 400 Hz	125 V AC 60 Hz
LAMP LOAD		
1	1	1
RESISTIVE LOAD		
5	5	5
INDUCTIVE LOAD		
2	2	2

LOGIC LEVEL

10 mA @ 5 V Max. (AC or DC)

SWITCH SELECTION TABLE — SEALED

	Circuit With Lever In...			Catalog Number
	UP Position	CENTER Position	DOWN Position (Position C)	
 SPDT	ON	OFF	ON	A121M1D9AG-M8
	ON	NONE	ON	A123M1D9AG-M8
	ON	NONE	ON*	A126M1D9AG-M8
	ON*	OFF	ON*	A127M1D9AG-M8
	ON	OFF	ON*	A131M1D9AG-M8
	NONE	ON	ON*	A134M1D9AG-M8
 DPDT	ON	OFF	ON	A221M1D9AG-M8
	ON	NONE	ON	A223M1D9AG-M8
	ON	NONE	ON*	A226M1D9AG-M8
	ON*	OFF	ON*	A227M1D9AG-M8
	ON	OFF	ON*	A231M1D9AG-M8
	ON	ON	ON	A232M1D9AG-M8
	ON	ON	ON*	A233M1D9AG-M8
	NONE	ON	ON*	A234M1D9AG-M8
	ON*	ON	ON*	A235M1D9AG-M8

* Momentary Contact

APPROXIMATE DIMENSIONS

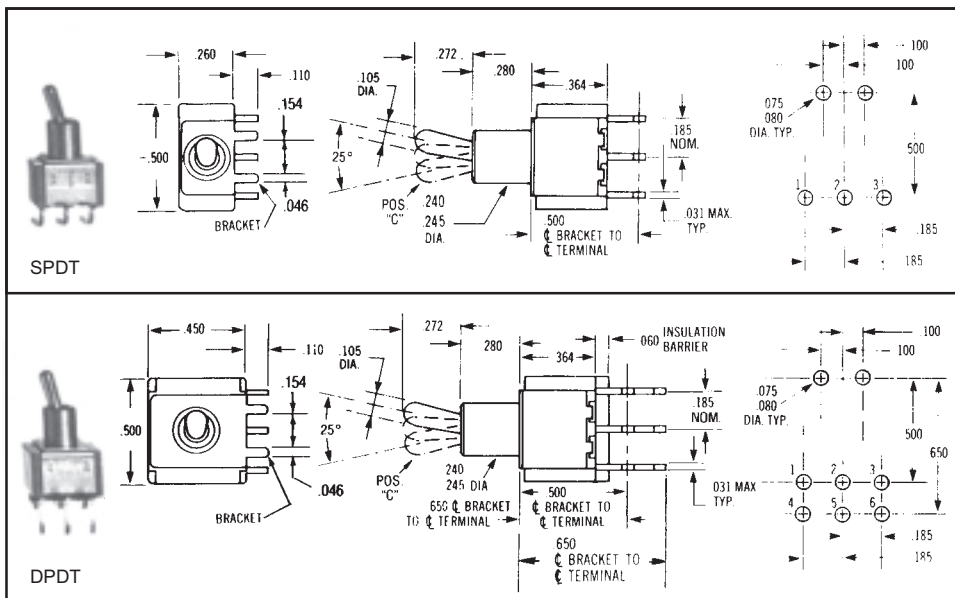

TERMINAL DIMENSIONS

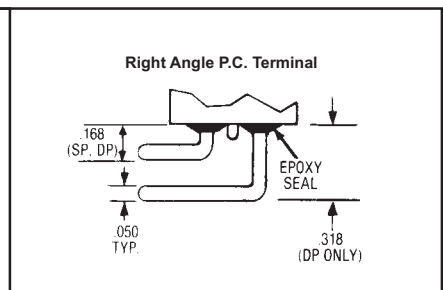

"ON-ON-ON" CIRCUIT DIAGRAM

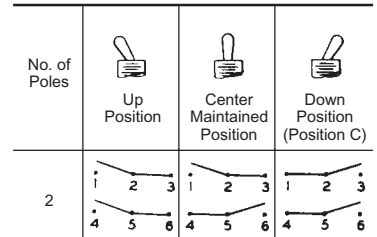

Commercial Miniature Toggle Switches – New Four Pole

SPECIFICATIONS

- Originally designed to meet the requirements of MIL-S-83731 (see page 54 for Test Specifications).
- Sealed lever type with panel seal and terminal seal.
- Flatted bushing on sealed lever type.
- Solder lug or printed circuit terminals.
- Epoxy sealed terminals.
- One and two pole circuits.
- High electrical/mechanical reliability.
- Dry circuit current carrying ability.
- Toggle lever throw 25° ±5°.

MATERIAL

- **Base (body)** — Diallyl Phthalate.
- **Lever** — Brass, bright chrome plated.
- **Locking Lever** — Brass, nickel plated.
Cap — natural anodized aluminum supplied as standard; other colors such as red, blue, gold, black and green are also available.
- **Bushing** — Brass, nickel plated.
Frame — Stainless steel.
- **Switching Contacts and Rockers** — 50 millionths gold over silver.
- **Center Terminal** — 50 millionths gold over silver.
- **Hardware** — Refer to hardware listing on page 57.

CURRENT RATINGS

Current Capacity in Amperes — Per Pole		
28 V DC	115 V AC 400 Hz	125 V AC 60 Hz
LAMP LOAD		
1	1	1
RESISTIVE LOAD		
5	5	5
INDUCTIVE LOAD		
2	2	2

LOGIC LEVEL

10 mA @ 5 V Max. (AC or DC)

SWITCH SELECTION TABLE — SEALED

	Circuit With Lever In...			Catalog Number	
	UP Position	CENTER Position	DOWN Position (Flat)	Solder Lug Terminals	Printed Circuit Terminals
 4-PDT	ON	OFF	ON	A421S1CWZG-M8	A421S1CWCG-M8
	ON	NONE	ON	A423S1CWZG-M8	A423S1CWCG-M8
	ON	NONE	ON*	A426S1CWZG-M8	A426S1CWCG-M8
	ON*	OFF	ON*	A427S1CWZG-M8	A427S1CWCG-M8
	ON	OFF	ON*	A431S1CWZG-M8	A431S1CWCG-M8
	ON	ON	ON	A432S1CWZG-M8	A432S1CWCG-M8
	ON	ON	ON*	A433S1CWZG-M8	A433S1CWCG-M8
	NONE	ON	ON*	A434S1CWZG-M8	A434S1CWCG-M8
	ON*	ON	ON*	A435S1CWZG-M8	A435S1CWCG-M8

* Momentary Contact

LEVER LOCK SELECTION TABLE — UNSEALED

Standard Cap Style	Circuit With Lever In...			Lever Lock Bushing Style	Catalog Number	
	UP Position	CENTER Position	DOWN Position (Keyway)		Solder Lug Terminals	Printed Circuit Terminals
 FOUR POLE	ON ►	◄ OFF ►	◄ ON	1	A421K12KZG-M8	A421K12KCG-M8
	ON ►	NONE	◄ ON	2	A423K12KZG-M8	A423K12KCG-M8
	ON ►	NONE	ON*	3	A426K12KZG-M8	A426K12KCG-M8
	ON*	◄ OFF ►	ON*	4	A427K12KZG-M8	A427K12KCG-M8
	ON ►	◄ OFF ►	ON*	5	A431K12KZG-M8	A431K12KCG-M8
	ON ►	◄ ON ►	◄ ON	1	A432K12KZG-M8	A432K12KCG-M8

* Momentary Contact

► Indicates direction against which lever is locked.

APPROXIMATE DIMENSIONS

(For terminal dimensions see page 49)

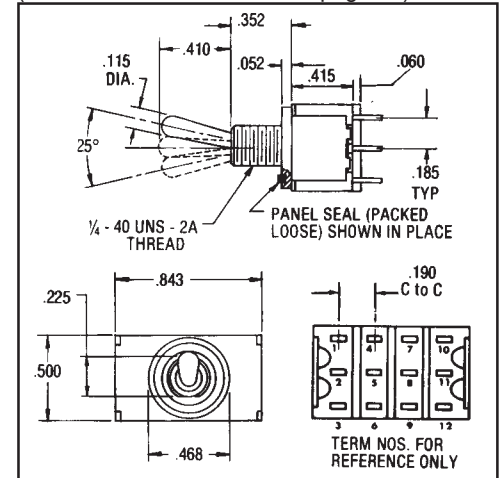

APPROXIMATE DIMENSIONS (For terminal dimensions see page 49)

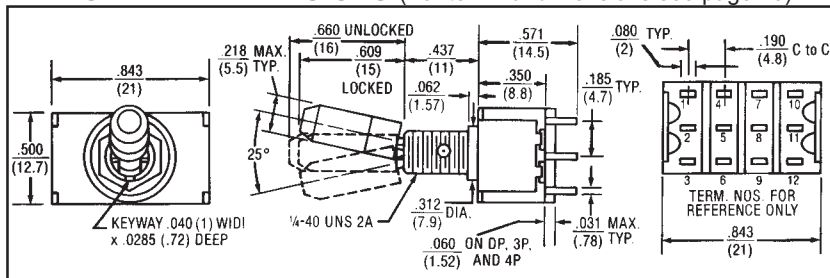

"ON-ON-ON"

CIRCUIT DIAGRAM

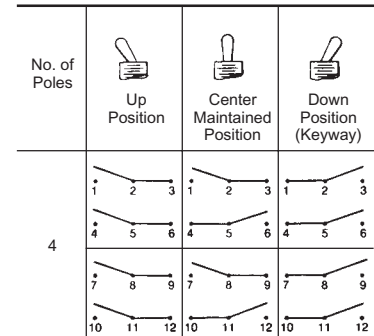

NOTE: FOR LEVER LOCK BUSHING STYLES SEE PAGE 50.

Rating, Cross Reference and Engineering Data
**“A” Series Originally Designed To Meet
the Following MIL Specifications**

Test Requirement	MIL Specification
1. Strength of Terminal	1 lb. — solder lug
2. Strength of Actuating Lever Pivot and Stop	10 lbs. & 8 lbs. throughout range
3. Strength of Mounting Means	15 lbs. in. torque on bushing
4. Dielectric (Sea Level) Indication Dielectric (Altitude)	1000 VAC Group C 750 VAC after electrical endurance. 500 μ A max. leakage
5. Contact Voltage Drop	2.5 millivolt initial 5.0 millivolt after mechanical endurance @ 2-6 VDC 0.1 amp.
6. Temperature Rise	50°C rise @ rated resistance after endurance test current
7. Short Circuit	10 operations make and carry 100 amps resistive load @ lowest DC volts
8. Mechanical Life	20K operations at specified high and low temperatures
9. Electrical Endurance	10K operations at specified high and low temperatures
10. Overload	50 operations @ 150% of rated resistive load
11. A) Electrical Endurance at Altitude	No requirement
B) Electrical Endurance at Sea Level	10K operations resistive load @ room temperature 10K operations inductive load @ room temperature 10K operations lamp load @ room temperature Performed on different test samples
12. Vibration	Method 204 of MIL-STD-202, test condition A .06 D.A. or 10 G's 10-500 Hz 10 usec. max. chatter
13. Shock	Fuse-method 213 or MIL-STD @75 G's 10 usec. max, chatter
14. Salt Spray Test Upon Completion	48 hours — method 101 of MIL-STD-202, test condition B 10 operations resistive load (toggle sealed switches only)
15. Moisture Resistance Test Upon Completion	Method 106 of MIL-STD-202 100 VDC potential between current carrying parts and panel
16. Sand & Dust	Method 110 of MIL-STD-202, test condition B 6 hours @ 23°C 2.5K operations mechanical life (toggle sealed switches only)
17. Explosion	MIL-STD-202 method 109, maximum rated DC inductive load (toggle sealed switches only)
18. Sealing	Toggle seal — 5 operations under 0.5 inches of H ₂ O above top of bushing
19. A) Toggle Seal B) Bushing Seal	No requirement
20. Temperature Operation	Mechanical life, -25°C to +71°C
21. Life Low Cur. Level	No requirement
22. Fungus	No requirement
23. Intermediate Current	10K operations, 50 milliamps @ 10 VDC resistive load @ 20,000 feet altitude @ room temperature
24. Thermal Shock	Method 107 of MIL-STD-202 test condition A 5 cycles @ -55°C/+85°C